

Crystal Clear Technology

Product Specification

T1010B01X00

(REVISION 12)

Crystal Clear Technology sdn. bhd.

16 Jalan TP5, Taman Perindustrian Sime UEP,
47600 Subang Jaya, Selangor DE
Malaysia.

T: +603 80247099 website: www.cct.com.my



1.0	Table of Content	Page
	1. Table of Content	1
	2. Record of Revision	2
	3. General Specification	3
	4. Absolute Maximum Ratings	4
	5. Electrical Characteristics	5 ~ 7
	6. Interface Connection	8 ~ 10
	7. Input Signal (DE Mode Only)	10 ~ 11
	8. Mechanical Specification	12 ~ 14
	9. Optical Characteristics	15 ~ 16
	10. Reliability Test.	17 ~ 18
	11. Precaution and limited warranty	19 ~ 23
	12. Attachment:	
	01. Capacitive Touch Panel Specification.	24 ~ 31



2.0 Record of Revision

Rev	Date	Item	Page	Comment
1	29/04/15			Preliminary
2	06/06/15	Mechanical spec.	12	Update CTP design
3	12/06/15	Add Gamma Voltage information		
4	30/06/15	Add CTP pin out	5	
5	30/06/15	Change CTP pin out	9	
6	17/08/15	Add CTP specification	9	
7	26/08/15	Update Mechanical Specification	12	Attachment
		Update CTP spec		Change backlight wire
		Add Precaution		length
8	09/09/15	Gamma Voltage	18	Overall
9	12/10/15	Backlight Specification	5	
		Update Mechanical Spec	7	
10	10/12/15	Pin Assignment	12	
		CTP General Spec	3	
11	11/05/16	Change display area dimension, change module size thickness, update drawing, change precaution for using TFT module, and add CCT website front page.	25	Backlight pin A and K
12	30/07/16	Change model name T1010B01W01 to T1010B01X00		



3.0 General Specification

T1010B01W01 is 10.1" colour TFT-LCD (Thin Film Transistor Liquid Crystal Display) module composed of LCD panel, driver ICs control circuit, LED backlight, CTP and cover lens. By applying 1024x600 images are displayed on the 10.1" diagonal screen. Display 16.2M colours by R.G.B signal input.

General Specification are summarized in the following table:

ITEM	SPECIFICATION	REMARK
Display Area (mm)	222.72 (W) x 125.28 (H)	
Number of Pixels	1024(H) (RGB) x 600 (V)	
Colour Pixel Arrangement	RGB vertical Stripe	
Display Mode	Normal White	
Number of colour	16.2M	1
Brightness (cd/m ²)	250 (typ)	3
Response Time (ms)	20ms (typ)	
Contrast Ratio	500 : 1 (min)	
Viewing angle (CR≥10)	140° (Horizontal)	
	120° (Vertical)	
Optimum Viewing Direction	6 O'clock (Grey Level Inversion)	
Power Consumption (mW)	480 (typ)	
Interface Connection	LVDS	
Module Size (mm)	247 (W) x 152 (H) x 6.5 (D)	2
Module Weight (g)	350	
Surface Treatment	Anti-Glare	

Note1: Colour tone is slightly changed by temperature and driving voltage.

Note2: Include CTP and cover lens. FPC or wire are not included.

Note3: Brightness on LCD surface. Module with CTP or RTP and cover lens, brightness will be about 20% (max) lower on the TP or cover lens surface.

AVAILABLE OPTION

X 0 0 X

TOUCH PANEL
 N : Without Touch Panel
 C : Capacitive Touch Panel
 R : Resistive Touch Panel

SEMI - CUSTOMISE (MINOR CHANGES FROM STANDARD MODEL)
 00 - STANDARD SPECIFICATION MODEL

OTHER OPTION
 C : STANDARD COVER LENS

REFER TO FACTORY FOR FURTHER INFORMATION.
 TERMS AND CONDITIONS APPLY



4.0 Absolute Maximum Ratings

Item	Symbol	Min	Max	Unit	Note
Digital Supply Voltage	VDD VDD_LVDS	-0.3	5	V	
Analog Supply Voltage	AVDD	-0.5	15	V	
Gate On Voltage	VGH	-0.3	42	V	
Gate off Voltage	VGL	-20	0.3	V	
Gate on-Gate Off Voltage	VGH-VGL	-0.3	40	V	
Signal Input Voltage	NIN0 ~ NIN2 PIN0 ~ PIN2 NINC, PINC	-0.5	5	V	
Forward Current(per LED)	I _f	-	30	mA	
Reverse Voltage (per LED)	V _R	-	5	V	
Pulse Forward Current (per LED)	I _{fp}	-	100	mA	Note1,2

Note 1: I_{fp} Conditions: Pulse Width ≤10msec; Duty ≤1/10.

Note 2: Operating must be under below condition.

(Ambient Temperature/Allowable Forward Current) Each LEDLG

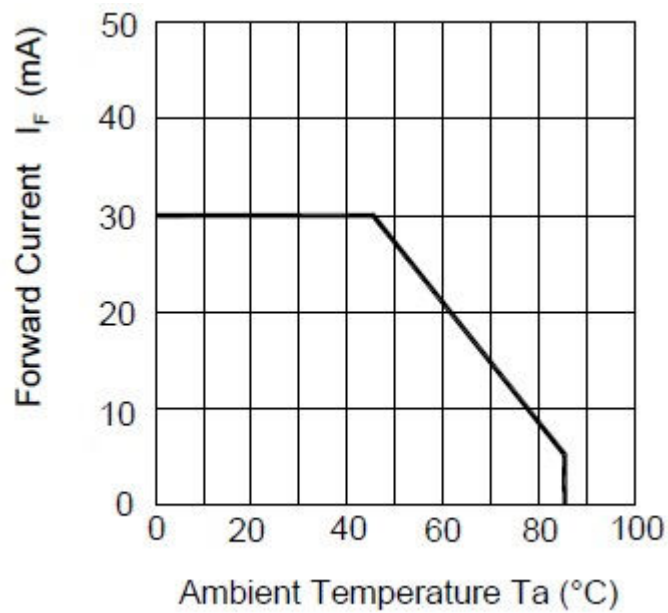



5.0 Electrical Characteristics

5.1 TFT LCD

ITEM	SYMBOL	MIN	TYP	MAX	UNIT	NOTE
Digital Power Supply Voltage for LCD	DVDD VDD_LVDS	3	3.3	3.6	V	
Logic Input Voltage (LVDS:IN+, In-)	VCM	$\frac{[VID]}{2}$	-	$\frac{2.4 - [VID]}{2}$	V	Note 1
	[VID]	200	-	600	mV	Note 1
	VTH	-	-	100	mV	VCM = 1.2V Note 1
	VTL	-100	-	-	mV	
Analog Power Supply Voltage	AVDD	9.4	9.6	9.8	V	
Gate On Power Supply Voltage	VGH	17	18	19	V	
Gate off Power Supply Voltage	VGL	-6.6	-6	-5.4	V	
Common Power Supply Voltage	VCCOM	3.6	4.0	4.2	V	Note2
Gamma Voltage	V1	-	9.02	-	V	
	V2	-	9.01	-	V	
	V3	-	7.62	-	V	
	V4	-	7.15	-	V	
	V5	-	6.85	-	V	
	V6	-	6.52	-	V	
	V7	-	6.46	-	V	
	V8	-	3.58	-	V	
	V9	-	3.5	-	V	
	V10	-	3.1	-	V	
	V11	-	2.76	-	V	
	V12	-	2.23	-	V	
	V13	-	0.67	-	V	
	V14	-	0.63	-	V	

Note 1: LVDS Signal

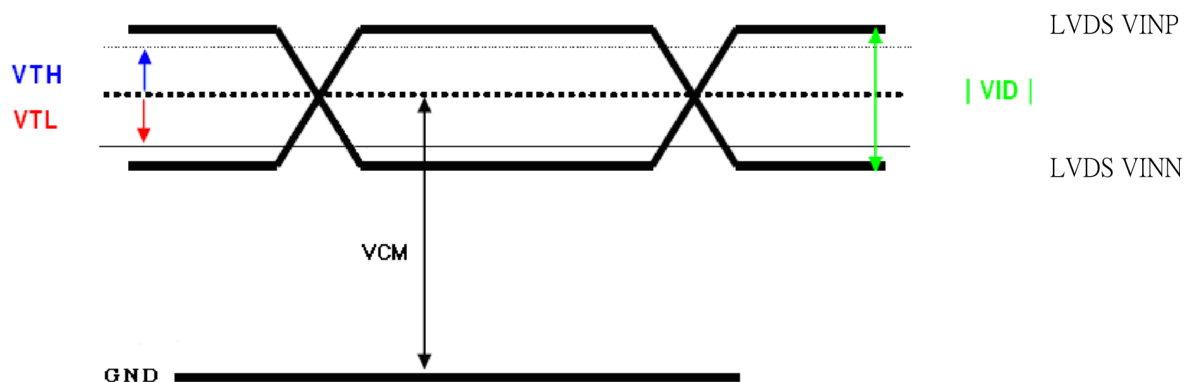

(Note2) Suggest to adjust VCOM to an optimum level to minimize flickering effect.



5.2 TFT-LCD Current Consumption

ITEM	SYMBOL	Condition	MIN	TYPE	MAX	UNIT	NOTE
Gate on power current	IVGH	VGH = 18V	-	0.5	1	mA	Note1
Gate off power current	IVGL	VGL = -6V	-	0.5	1	mA	Note1
Digital power current	IVDD	VDD = 3.3V	-	40	50	mA	Note1
Analog power current	IAVDD	AVDD = 9.6V	-	35	45	mA	Note1
Total Power Consumption	PC		-	480	621	mW	Note1

Note1: Typical: Under 256 grey pattern
Maximum: Under black Pattern



256 grey pattern

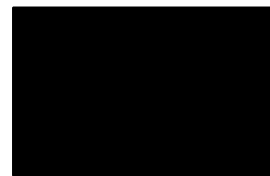

Black Pattern

5.3 Power Signal sequence

Power On: VDD → AVDD/VGL → VGH → Video & Logic Signal

Power Off: Video & Logic Signal → VGH → AVDD/VGL → VDD

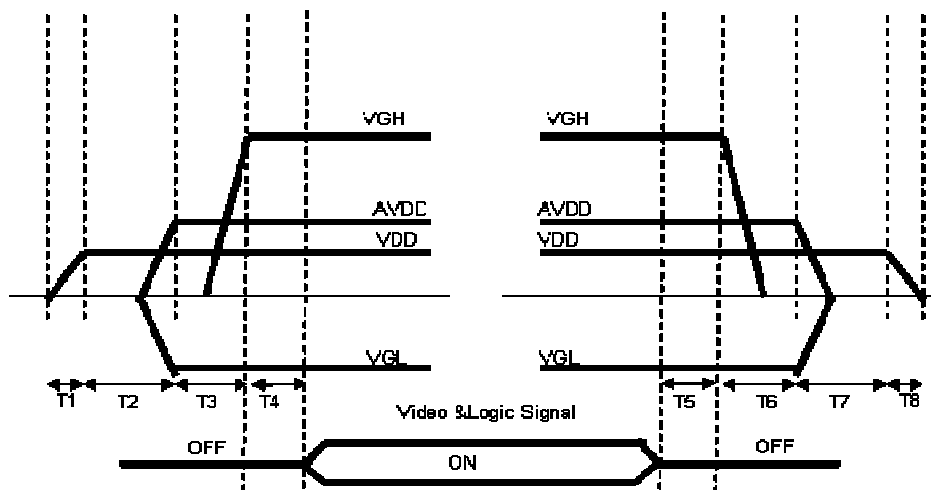

$0 < T1 \leq 10ms$
 $20ms < T2$
 $10ms < T3$
 $0 < T4 \leq 10ms$

$0 < T5 \leq 10ms$
 $0 < T6$
 $0 < T7$
 $0 < T8$



5.4 Backlight

Ta = 25°C

ITEM	SYMBOL	CONDITIONS	MIN	TYP	MAX	UNIT	NOTE
LED current	IL	Ta=25°C (30mA/series)	--	390	--	mA	
LED voltage	VL	Ta=25°C (30mA/series)	9.2	9.6	9.8	V	
LED Lifetime	-	Ta=25°C IF=30mA	35000			Hr	

Remarks:

- 1) LED Circuit Diagram

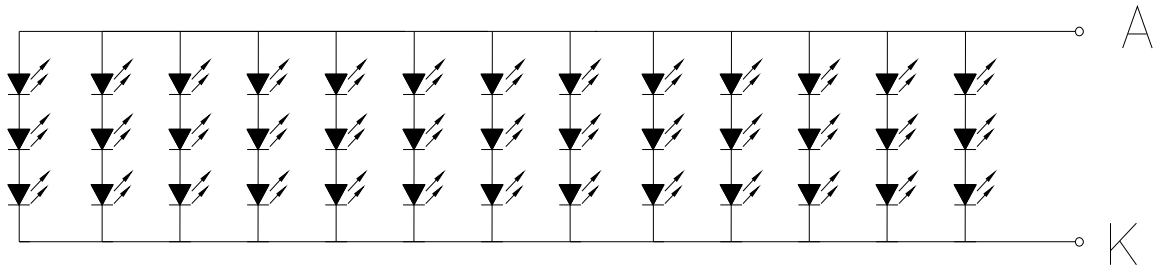

- 2) Suggestion: Use constant current control to avoid light leakage phenomenon and uneven brightness quality issue
- 3) Definition of lifetime : Luminance < 50% of initial Luminance



6.0 Interface Connection

6.1 CN1 (Input Signal)

PIN NO	SYMBOL	DESCRIPTION
1	AGND	Analog ground
2	AVDD	Analog power
3	VDD	Digital power
4	GND	Digital ground
5	VCOM	Common voltage
6	VDD	Digital power
7	GND	Digital ground
8	V14	Gamma correction voltage reference
9	V13	Gamma correction voltage reference
10	V12	Gamma correction voltage reference
11	V11	Gamma correction voltage reference
12	V10	Gamma correction voltage reference
13	V9	Gamma correction voltage reference
14	V8	Gamma correction voltage reference
15	GND	Digital ground
16	VDD_LVDS	LVDS power
17	GND	Digital ground
18	PIND3	Positive LVDS differential data inputs
19	NIND3	Negative LVDS differential data inputs
20	GND	Digital ground
21	PINC	Positive LVDS differential clock inputs
22	NINC	Negative LVDS differential clock inputs
23	GND	Digital ground
24	PIND2	Positive LVDS differential data inputs
25	NIND2	Negative LVDS differential data inputs
26	GND	Digital ground
27	PIND1	Positive LVDS differential data inputs
28	NIND1	Negative LVDS differential data inputs
29	GND	Digital ground
30	PIND0	Positive LVDS differential data inputs
31	NIND0	Negative LVDS differential data inputs
32	GND	Digital ground
33	GND_LVDS	LVDS ground
34	GRB	Global reset pin. Active low to enter reset state. Suggest to connecting with an RC reset circuit for stability. Normally pull high. (R=10KΩ , C=0.1 μF)
35	STBYB	Standby mode, normally pul. high STBYB=" 1" , normal operation STBYB=" 0" , timing control, source driver will turn off, all output are high-Z.
36	SILR	Left or right display control
37	VDD	Digital power
38	UPDN	Up / down display control
39	AGND	Analog ground
40	AVDD	Analog power
41	VCOM	Common voltage
42	DITH	Dithering function enable control. Normally pull low DITHER = "1" , Enable internal dithering function DITHER = "0" , Disable internal dithering function
43	GND	Digital ground
44	VDD	Digital Power
45	GND	Digital ground



46	V7	Gamma correction voltage reference
47	V6	Gamma correction voltage reference
48	V5	Gamma correction voltage reference
49	V4	Gamma correction voltage reference
50	V3	Gamma correction voltage reference
51	V2	Gamma correction voltage reference
52	V1	Gamma correction voltage reference
53	GND	Digital ground
54	VDD	Digital power
55	SELB	6bit/8bit mode select, SELB = "0", LVDS input data is 8bits SELB = "1", LVDS input data is 6bits
56	VGH	Positive power for TFT
57	VDD	Digital power for Gate IC
58	VGL	Negative power for TFT
59	GND	Digital ground for Gate IC
60	NC	No connection

Remarks:

- 1) Mating Connector : 089K60-000100-G2-R (STARCONN)
- 2) UPDN and SHLR control function

6.2 Capacitive Touch Panel pin out

PIN	SYMBOL
1	VDD
2	GND
3	GND
4	SCL
5	SDA
6	GND
7	INT
8	RST

6.3 CN2 (LED Backlight)

PIN NO	SYMBOL	FUNCTION
1	A	Anode
2	K	Cathode

Note:

Input Connector: BHSR-02VS-1 (JST)

Output Connector: SM02B-BHSS-1 (JST)



7.0 Input Signal (DE Only Mode)
7.1 Timing Specification

ITEM			SYMBOL	MIN	TYP	MAX	UNIT	
LVDS input signal sequence	CLK Frequency		tclk	45	51.2	57	MHz	
LCD input Signal Sequence (Input LVDS Transmitter)	DENA	Horizontal	Horizontal total Time	t _H	1324	1344	1364	tCLK
			Horizontal effective Time	t _{HA}	1024			tCLK
			Horizontal Blank Time	t _{HB}	300	320	340	tCLK
	Vertical	Vertical total Time	t _V	625	635	645	t _H	
		Vertical effective Time	t _{VA}	600			t _H	
		Vertical Blank Time	t _{VB}	25	35	45	t _H	

7.2 Timing Sequence (Timing Chart)

7.2.1 Horizontal Timing Sequence

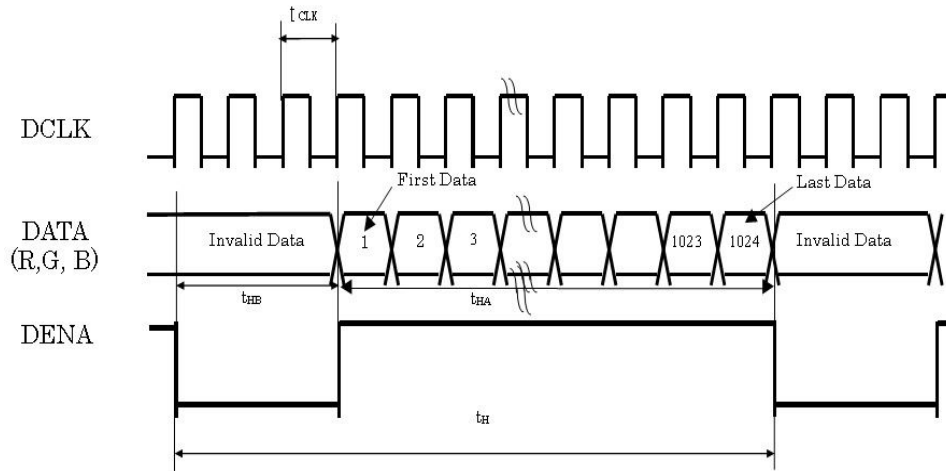

7.2.2 Vertical Timing Sequence

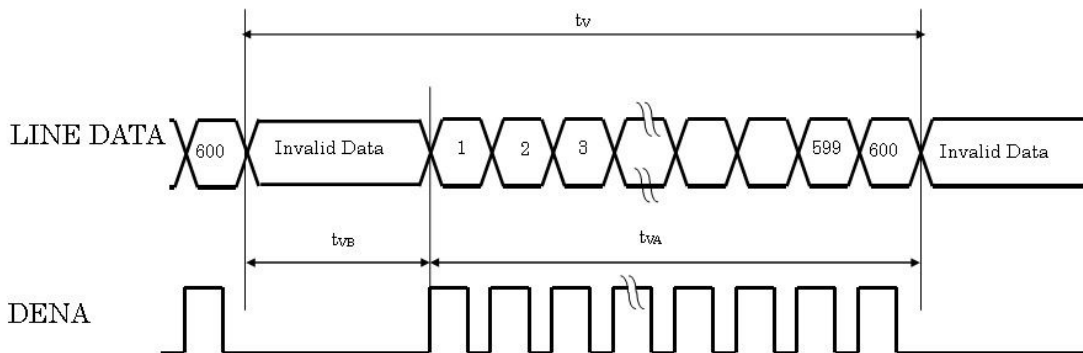



7.2.3 LVDS Input Data Mapping

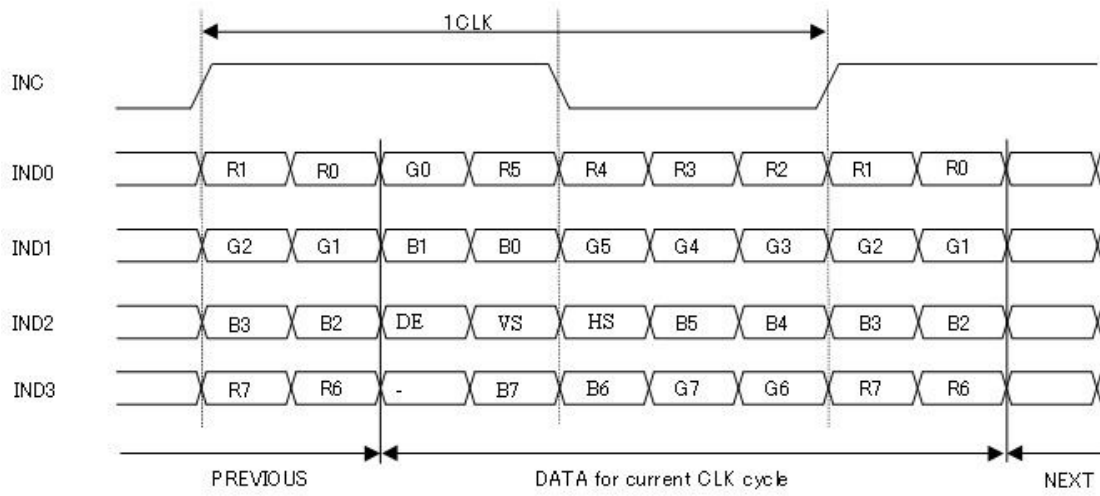

8.0 Mechanical Specification

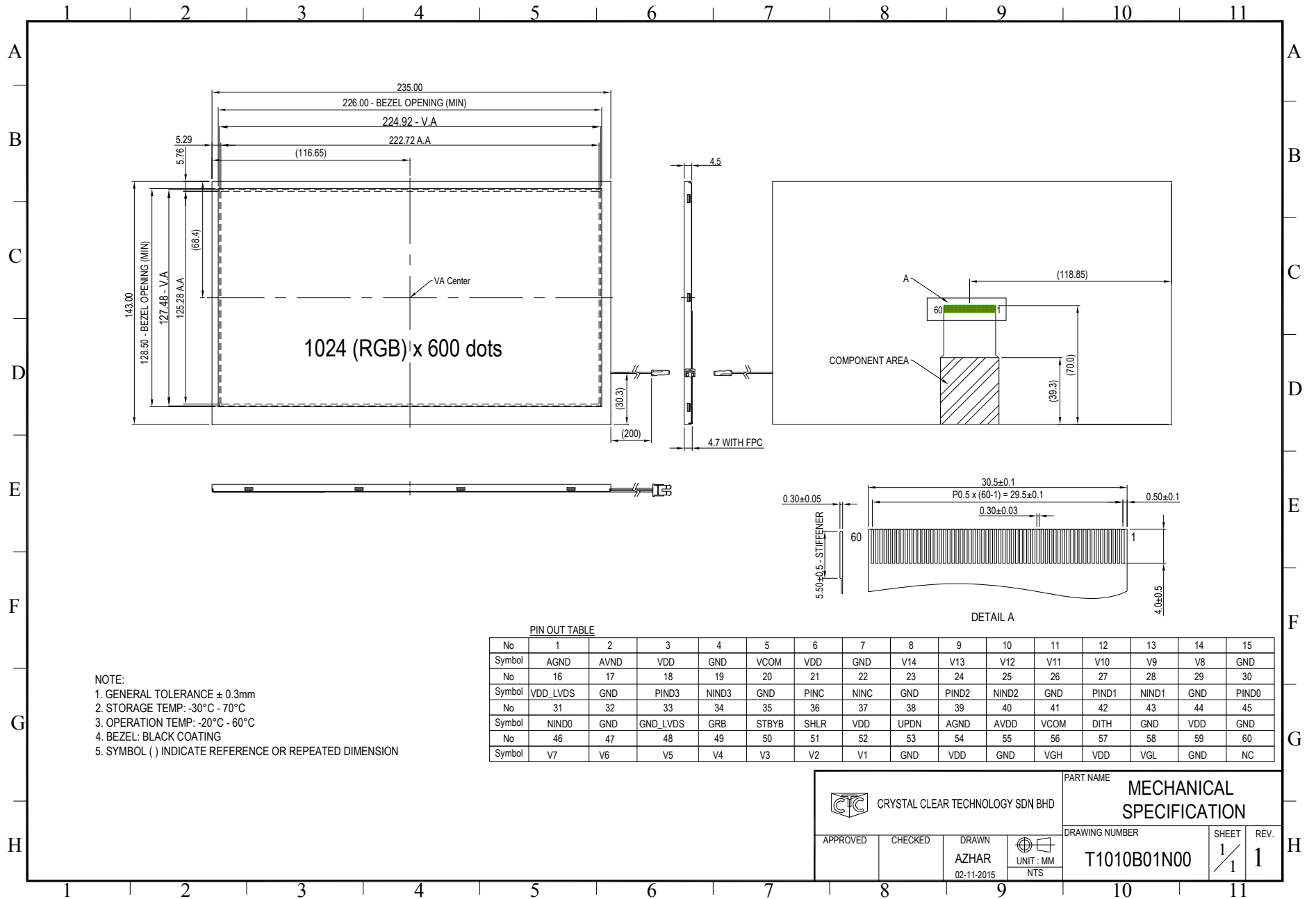

NOTE:
 1. GENERAL TOLERANCE $\pm 0.3\text{mm}$
 2. STORAGE TEMP: $-30^{\circ}\text{C} - 70^{\circ}\text{C}$
 3. OPERATION TEMP: $-20^{\circ}\text{C} - 60^{\circ}\text{C}$
 4. BEZEL: BLACK COATING
 5. SYMBOL () INDICATE REFERENCE OR REPEATED DIMENSION

PIN OUT TABLE

No	1	2	3	4	5	6	7	8	9	10	11	12	13	14	15
Symbol	AGND	AVND	VDD	GND	VCOM	VDD	GND	V14	V13	V12	V11	V10	V9	V8	GND
No	16	17	18	19	20	21	22	23	24	25	26	27	28	29	30
Symbol	VDD_LVDS	GND	PIND3	NIND3	GND	PINC	NINC	GND	PIND2	NIND2	GND	PIND1	NIND1	GND	PIND0
No	31	32	33	34	35	36	37	38	39	40	41	42	43	44	45
Symbol	NIND0	GND	GND_LVDS	GRB	STBYB	SHLR	VDD	UPDN	AGND	AVDD	VCOM	DITH	GND	VDD	GND
No	46	47	48	49	50	51	52	53	54	55	56	57	58	59	60
Symbol	V7	V6	V5	V4	V3	V2	V1	GND	VDD	GND	VGH	VDD	VGL	GND	NC

CRYSTAL CLEAR TECHNOLOGY SDN BHD				PART NAME	
				MECHANICAL SPECIFICATION	
APPROVED	CHECKED	DRAWN	UNIT : MM NTS	DRAWING NUMBER	SHEET
		AZHAR 02-11-2015		T1010B01N00	
				REV.	1

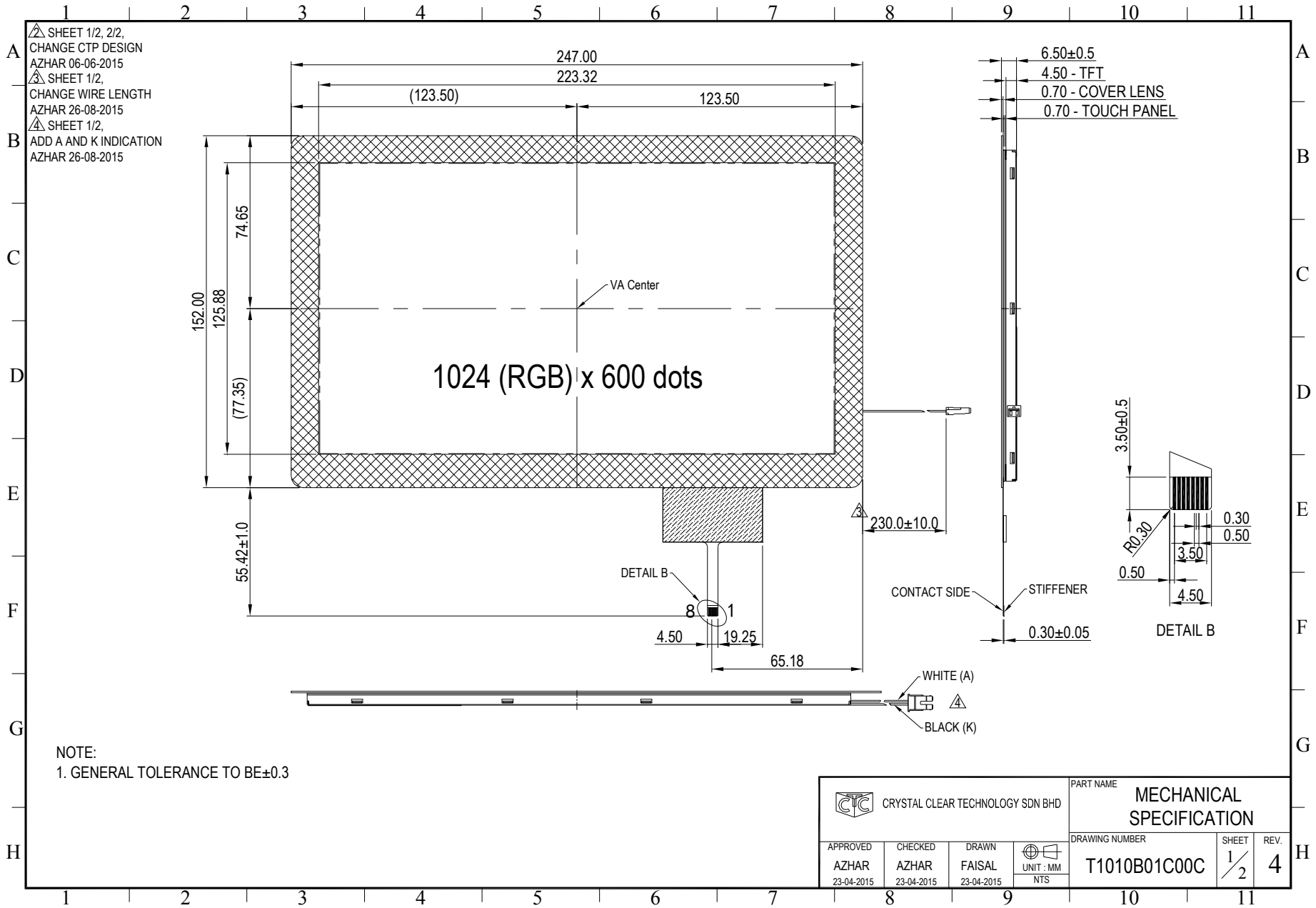



△ SHEET 1/2, 2/2,
 CHANGE CTP DESIGN
 AZHAR 06-06-2015
 △ SHEET 1/2,
 CHANGE WIRE LENGTH
 AZHAR 26-08-2015
 △ SHEET 1/2,
 ADD A AND K INDICATION
 AZHAR 26-08-2015

NOTE:
 1. GENERAL TOLERANCE TO BE ±0.3

CRYSTAL CLEAR TECHNOLOGY SDN BHD				PART NAME MECHANICAL SPECIFICATION	
APPROVED AZHAR 23-04-2015	CHECKED AZHAR 23-04-2015	DRAWN FAISAL 23-04-2015	UNIT : MM NTS	DRAWING NUMBER T1010B01C00C	SHEET 1/2
				REV. 4	

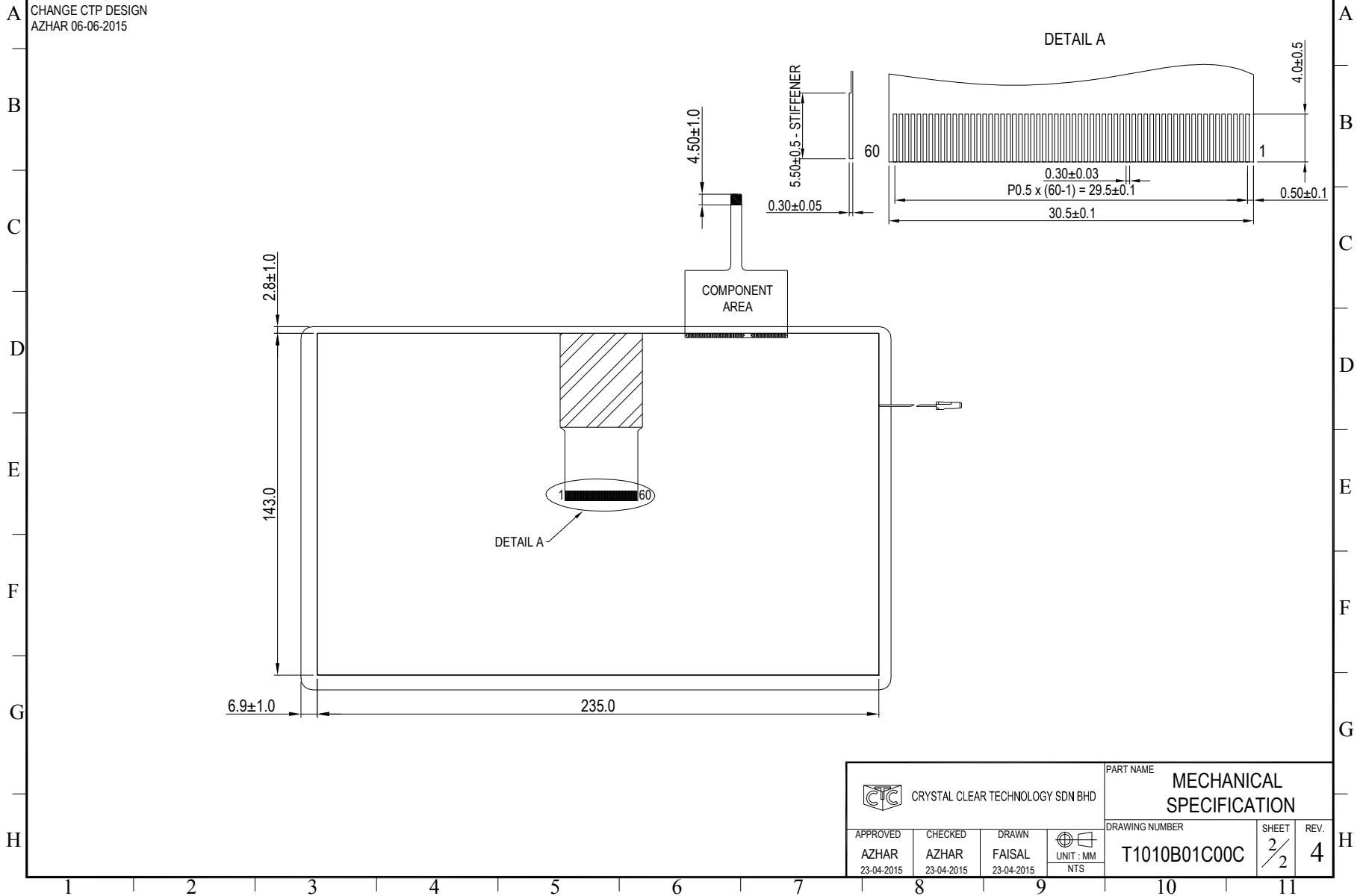
△ SHEET 2/2,
CHANGE CTP DESIGN
AZHAR 06-06-2015



 CRYSTAL CLEAR TECHNOLOGY SDN BHD				PART NAME MECHANICAL SPECIFICATION	
APPROVED AZHAR 23-04-2015	CHECKED AZHAR 23-04-2015	DRAWN FAISAL 23-04-2015	 UNIT : MM NTS	DRAWING NUMBER T1010B01C00C	SHEET 2/2
				REV. 4	



9.0 Optical Characteristics

Ta = 25°C, VCC = 3.3V

Item	Symbol	Condition	Min.	Typ.	Max	Unit	
Panel Transmittance	T	--	5.5	5.9	--	%	
LCM luminance (Center)	YL	I=140mA	400	450	--	cd/m ²	
Response time	Rising	TR	Point-5	20	40	ms	
	Falling	TF					
Viewing Angle	Horizontal	f	CR ≥ 10	120	140	--	°
	Vertical	q		100	120	--	
Color Filter Chromaticity	White.	X	q=Ø= 0°	0.28	0.30	0.33	
		Y		0.30	0.32	0.35	

Note1: Measuring condition : 25°C±2°C, 60±10%RH, under 10 Lux luminosity, in a dark room.

Using BM-5A (TOPCON), viewing angle 2°, IL=140 mA (Backlight current measurement is taken after lighting is switched-on for a duration of 10 min).

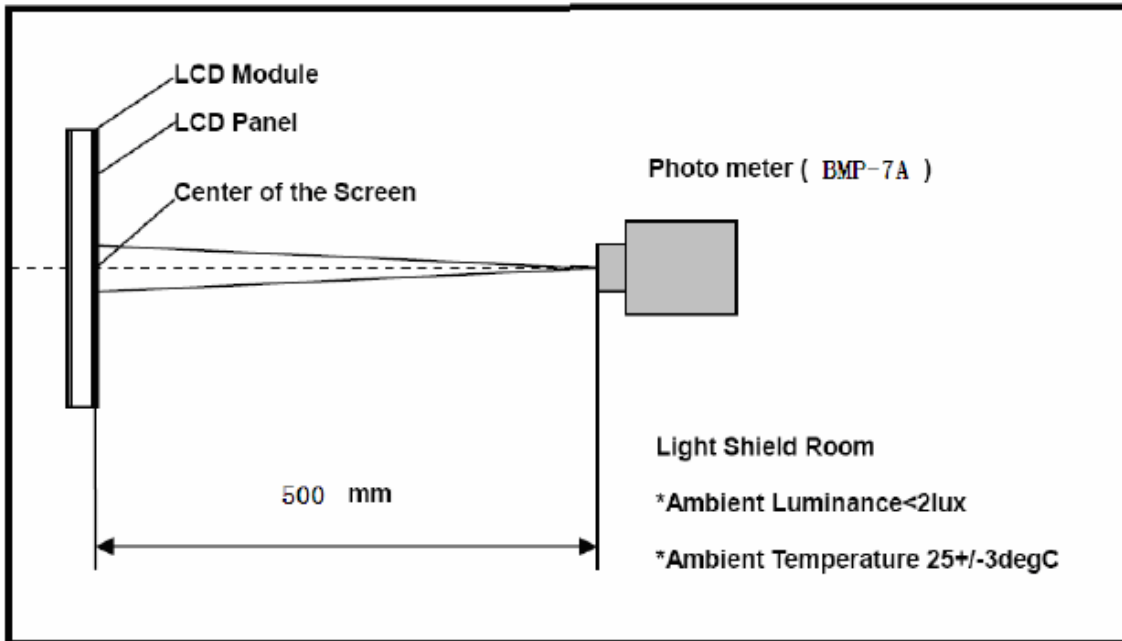

Note2: Definition of contrast ratio:

Contrast Ratio (CR) = (White) Luminance when pixel is switched ON ÷ (Black) Luminance when pixel is switched OFF



Note3: Definition of luminance:

Measurement of white luminance on point 5 with reference to Figure 9-1.

Definition of luminance uniformity:

Measurement of white luminance on point 1~9 with reference to Figure 9-1 and subjecting the data to the following equation:

$$\Delta L = [L(\text{MIN})/L(\text{MAX})] \times 100$$

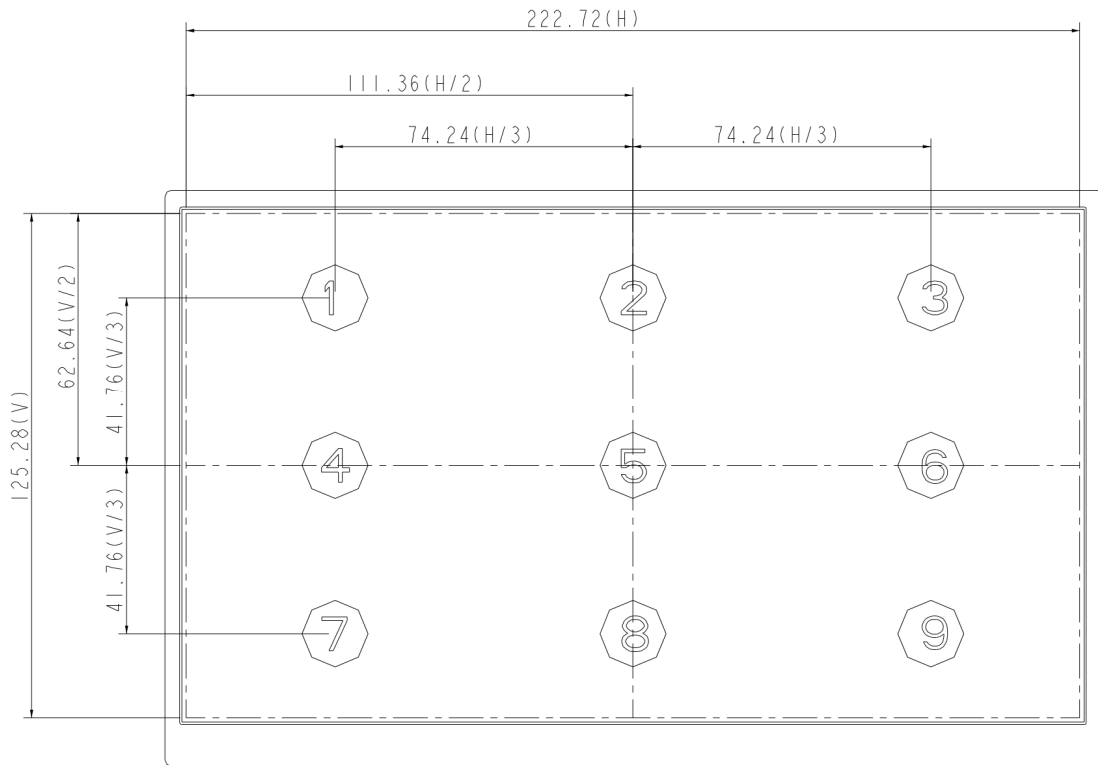

Fig. 9-1 measuring Point

Note 4: Definition of Viewing Angle (θ, ψ) refer to Fig 9-2

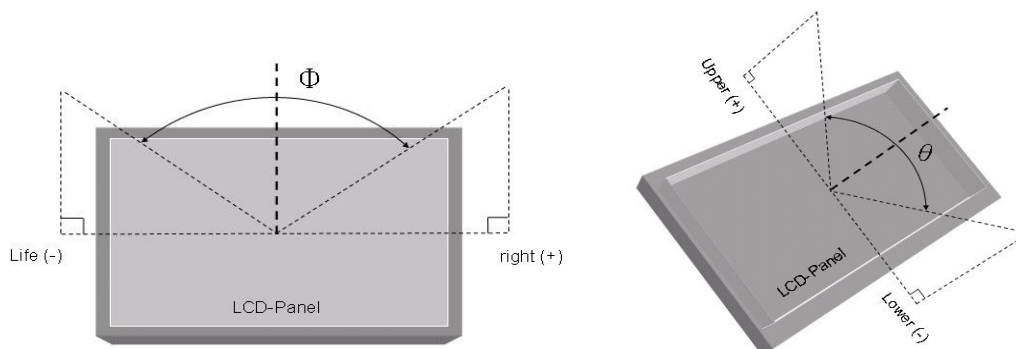
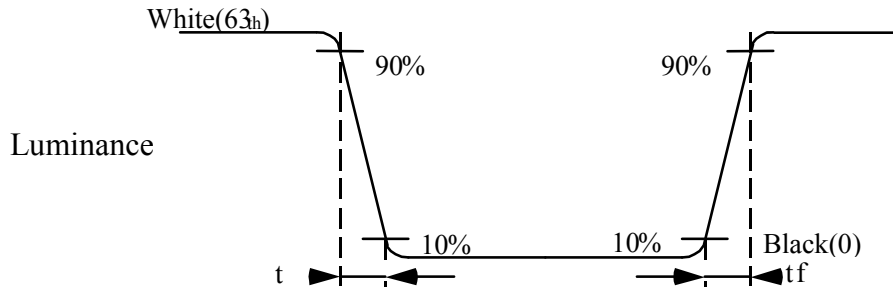

Fig. 9-2: Definition of Viewing Angle



Note 5: Definition of Response Time (White-Black)



10.0 Reliability Test

10.1 Temperature and Humidity

TEST ITEMS	CONDITIONS	NOTE
High Temperature Operation	70°C ; 240hrs	
High Temperature Storage	80°C ; 240hrs	
High Temperature High Humidity Operation	60°C ; 90%RH ;240hrs	No condensation
Low Temperature Operation	-20°C; 240hrs	Backlight unit always turn on
Low Temperature Storage	-30°C; 240hrs	
Thermal Shock	-30°C (0.5hr) ~ 80°C (0.5hr) ; 200 Cycles	
Image Sticking	40°C; 24hrs	Note 1

Note 1 : Condition of Image Sticking test : 25 °C± 2 °C. Operation with sustained test pattern for 24 hrs, then change to grey pattern immediately. After 5 min, the mural should disappear completely.

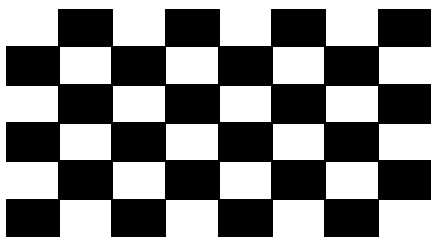

Image Sticking-Pattern



Grey - Pattern

10.2 Shock and Vibration

TEST ITEMS	CONDITIONS
Shock (Non-operation)	<ul style="list-style-type: none"> ● Shock level: 980m/s²(equal to 100G). ● Waveform: half sinusoidal wave,6ms. ● Number of shocks: ±X,±Y,±Z axes for a total of six shock inputs.
Vibration (Non-operation)	<ul style="list-style-type: none"> ● Frequency range:8~33.3Hz ● Stoke : 1.3 mm ● Vibration: sinusoidal wave, perpendicular axis(both x, y axis: 2hrs ,z axis: 4hrs). ● Sweep: 2.9G,33.3 Hz -400 Hz ● Cycle time: 15 min



10.3 Electrostatic Discharge

TEST ITEM	CONDITIONS	Note
ESD	150pF, 330Ω, ±8kV&±15kV air& contact test	1
	200pF, 0Ω, ±200V contact test	2

Note: Measure: 1 – LCD glass and metal bezel
2. IF connector pins

10.4 Judgement Standard

The Judgment of the above test should be made as follow:

Pass: Normal display image with no obvious non-uniformity and no line defect.

Partial transformation of the module parts should be ignored.

Fail: No display image, obvious non-uniform display quality.

Notes:

1. If the module is used above these absolute maximum ratings, it may become permanently damaged. Using the module exceeding the following electrical characteristic conditions, the module will malfunction and cause poor reliability.
2. $V_{CC} > V_{SS}$ must be maintained.
3. Please be sure users are grounded when handing LCD Module.



11.0 Precaution for Using TFT Modules

1. Handling Precautions

- a. The display panel is made of glass and polarizer. As glass is fragile. It tends to chip during handling especially on the edges. Please avoid dropping or jarring. Do not subject it to a mechanical shock of impact or by dropping it.
- b. If the display panel is damaged and the liquid crystal substance leaks out, be sure not to get any in your mouth. If the substance is in contact with your skin or clothes, wash it off using soap and water.
- c. Do not apply excessive force to the display surface or the adjoining areas since this may cause the colour tone to vary. Do not touch the display with bare hands. This will stain the display area and degrade the insulation between terminals. Scratch and dents may occur on polarizer too.
- d. The polarizer covering the display surface of the LCD module is soft and easily scratched. Handle this polarizer carefully. Do not touch, push or rub the exposed polarizers with anything harder than a HB pencil lead (glass, tweezers, etc.). Do not put or attach anything on the display area to avoid leaving marks on it. Condensation on the surface and contact with terminals due to cold will damage, stain or dirty the polarizer. After products are tested at low temperature they must be warmed up in a container before coming in to contact with room temperature air.
- e. If the display surface becomes contaminated, breathe on the surface and gently wipe it with a soft dry cloth. If it is heavily contaminated, moisten cloth with one of the following solvents
 - Isopropyl alcohol
 - Ethyl alcohol
 - Do not scrub hard to avoid damaging the display surface.
- f. Solvents other than those above-mentioned may damage the polarizer. Especially, do not use the following.
 - Water
 - Ketone
 - Aromatic solvents
 - Wipe off saliva or water drops immediately, contact with water over a long period of time may cause deformation or colour fading. Avoid contact with oil and fats.
- g. Exercise care to minimize corrosion of the electrode. Corrosion of the electrodes is accelerated by water droplets, moisture condensation or a current flow in a high-humidity environment.
- h. Install the LCD Module by using the mounting holes. When mounting the LCD module make sure it is free of twisting, warping and distortion. In particular, do not forcibly pull or bend the I/O cable or the backlight cable.
- i. Do not attempt to disassemble or process the LCD module.
- j. NC terminal should be open. Do not connect anything.
- k. If the logic circuit power is off, do not apply the input signals.
- l. Electro-Static Discharge Control. Since this module uses a CMOS LSI, the same careful attention should be paid to electrostatic discharge as for an ordinary CMOS IC. To prevent destruction of the elements by static electricity, be careful to maintain an optimum work environment.
 - Before removing LCM from its packing case or incorporating it into a set, be sure the module and your body have the same electric potential. Be sure to ground the body when handling the LCD modules.
 - Tools required for assembly, such as soldering irons, must be properly grounded. Make certain the AC power source for the soldering iron does not leak. When using an electric screwdriver to attach LCM, the screw driver should be of ground potentiality to minimize as much as possible any



transmission of electromagnetic waves produced sparks coming from the commutator of the motor.

- To reduce the amount of static electricity generated, do not conduct assembly and other work under dry conditions. To reduce the generation of static electricity be careful that the air in the work environment is not too dry. A relative humidity of 50%-60% is recommended. As far as possible make the electric potential of your work clothes and that of the work bench the ground potential.
 - The LCD module is coated with a film to protect the display surface. Exercise care when peeling off this protective film since static electricity may be generated.
- m. Since LCM has been assembled and adjusted with a high degree of precision, avoid applying excessive shocks to the module or making any alterations or modifications to it.
- Do not alter, modify or change the shape of the tab on the metal frame.
 - Do not make extra holes on the printed circuit board, modify its shape or change the positions of components to be attached.
 - Do not damage or modify the pattern writing on the printed circuit board.
 - Absolutely do not modify the zebra rubber strip (conductive rubber) or heat seal connector.
 - Except for soldering the interface, do not make any alterations or modifications with a soldering iron.
 - Do not drop, bend or twist the LCM.

2. Storage Precautions

When storing the LCD modules, the following precaution are necessary.

- a. Store them in a sealed polyethylene bag. If properly sealed, there is no need for the desiccant.
- b. Store them in a dark place. Do not expose to sunlight or fluorescent light, keep the temperature between 0°C and 35°C, and keep the relative humidity between 40%RH and 60%RH.
- c. The polarizer surface should not come in contact with any other objects.

3. Others

- a. Liquid crystals solidify under low temperature (below the storage temperature range) leading to defective orientation or the generation of air bubbles (black or white). Air bubbles may also be generated if the module is subject to a low temperature.
- b. If the LCD modules have been operating for a long time showing the same display patterns, the display patterns may remain on the screen as ghost images and a slight contrast irregularity may also appear. A normal operating status can be regained by suspending use for some time. It should be noted that this phenomenon does not adversely affect performance reliability.
- c. To minimize the performance degradation of the LCD modules resulting from destruction caused by static electricity etc. Exercise care to avoid holding the following sections when handling the modules.
 - Exposed area of the printed circuit board.
 - Terminal electrode sections.

4. Using LCD Modules

a. Installing LCD Modules

The hole in the printed circuit board is used to fix LCM as shown in the picture below.

Attend to the following items when installing the LCM.



- b. Cover the surface with a transparent protective plate to protect the polarizer and LC cell.

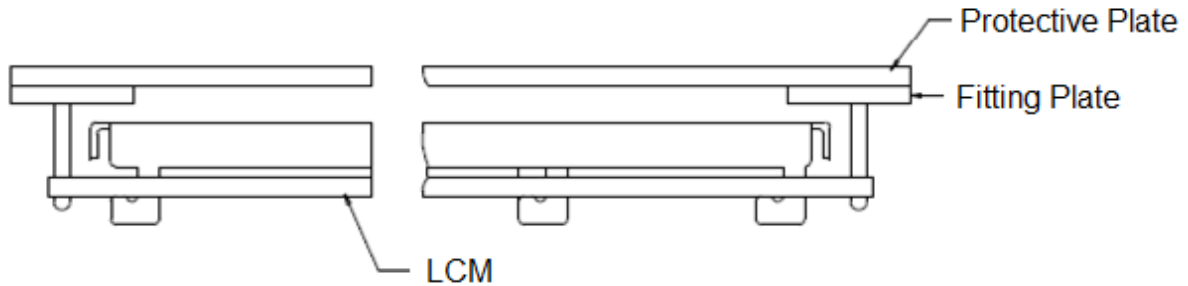

- c. When assembling the LCM into other equipment, the spacer to the bit between the LCM and the fitting plate should have enough height to avoid causing stress to the module surface, refer to the individual specifications for measurements. The measurement tolerance should be 0.1mm.
- d. Precaution for assemble the module with BTB connector:
Please note the position of the male and female connector position, don't assemble or assemble like the method which the following picture shows

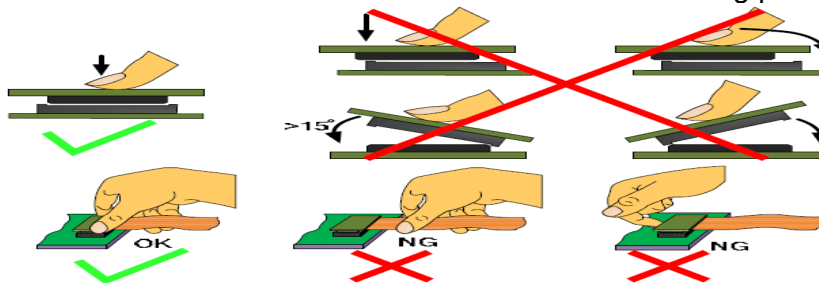

5. Precaution for soldering the LCM

	Manual soldering	Machine drag soldering	Machine press soldering
No RoHS Product	290°C ~350°C. Time: 3-5S.	330°C ~350°C. Speed: 4-8 mm/s.	300°C ~330°C. Time: 3-6S. Press: 0.8~1.2Mpa
RoHS Product	340°C ~370°C. Time: 3-5S.	350°C ~370°C. Time: 4-8 mm/s.	330°C ~360°C. Time: 3-6S. Press: 0.8~1.2Mpa

- a. If soldering flux is used, be sure to remove any remaining flux after finishing the soldering operation (This does not apply in the case of a non-halogen type of flux). It is recommended that you protect the LCD surface with a cover during soldering to prevent any damage due to flux spatters.
- b. When soldering the electroluminescent panel and PC board, the panel and board should not be detached more than three times. This maximum number is determined by the temperature and time conditions mentioned above, though there may be some variance depending on the temperature of the soldering iron.
- c. When removing the electroluminescent panel from the PC board, be sure the solder has completely melted, the soldered pad on the PC board could be damaged.

6. Precautions for Operation

- a. Viewing angle varies with the change of liquid crystal driving voltage (VLCD). Adjust VLCD to show the best contrast.
- b. It is recommended to drive LCD's within the specified voltage limit since over limit will cause shorter LCD life. An electrochemical reaction due to direct current causes LCD-deterioration. Avoid the use of direct current drive.



- c. Response time will be extremely delayed at lower temperature compared to room operating temperature range and on the other hand, at higher temperature LCD shows dark colour in them. However those phenomena do not mean malfunction. The LCD will return to normal performance when ambient temperature revert to room condition.
- d. If the display area is pushed hard during operation, the display will become abnormal. However, it will return to normal if it is turned off and on.
- e. A slight dew depositing on terminals is a cause for electro-chemical reaction resulting in terminal open circuit.
- f. Input logic voltage before apply analogue high voltage such as LCD driving voltage when power on. Remove analogue high voltage before logic voltage when power off the module. Input each signal after the positive/negative voltage becomes stable.
- g. Please keep the temperature within the specified range for use and storage. Polarization degradation, bubble generation or polarizer peel-off may occur with high temperature and high humidity.

7. Safety

- a. It is recommended to crush damaged or unnecessary LCDs into pieces and wash them off with solvents such as acetone and ethanol, which should later be burned.
- b. If any liquid leaks out of a damaged glass cell and comes in contact with the hands, wash off thoroughly with soap and water.

8. Limited Warranty

Unless otherwise agreed between Crystal Clear Technology and customer, Crystal Clear Technology will replace or repair any of its LCD and LCM which is found to be defective electrically and visually when inspected in accordance with Crystal Clear Technology acceptance standards, for a period of one year from date of shipment. Confirmation of such date shall be based on freight documents. The warranty liability of Crystal Clear Technology is limited to repair and/or replacement on the terms set forth above. Crystal Clear Technology will not responsible for any subsequent or consequential events.

9. Return LCM under Warranty

No warranty can be granted if the precautions stated above have been disregarded. The typical examples of violations are:

- Broken LCD glass
- PCB eyelet's damaged or modified
- PCB conductors damaged
- Circuit modified in any way, including addition of components.
- PCB tampered with by grinding, engraving or painting varnish.
- Soldering to, or modifying the bezel in any manner.

Module repairs will be invoiced to customer upon mutual agreement. Modules must be returned with sufficient description of failure or defects. Any connectors or cable installed by customer must be removed completely without damaging the PCB eyelet's, conductors and terminals.



Attachment 1.

Capacitive Touch Panel Specification



Contents

1. General Specification
2. Electrical Characteristics
3. Optical Characteristics
4. Reliability
5. Durability
6. Touch panel description
 - 6.1 Block diagram
 - 6.2 Touch panel pin assignment
7. Appearance Inspection
 - 7.1 Inspection Conditions
 - 7.2 Appearance Standard

**1. General Specification**

Item	CONTENTS	Unit
Outline Dimension	247*152	mm
Active Area(W*L)	224.32*126.88	mm
View Area	223.32*125.88	mm
TP size (inch)	10.1	inch
Controller IC	FT5426	
Interface Type	IIC	-
I2C Slave Address	0X38	
Number of touch point	1024x600(5Point)	Dot
Number of button	--	-
Operation Temperature	TOPL = -20, TOPH =70	°C
Storage Temperature	TSTL = -30, TSTH =80	°C
ITO Glass thickness ITO	0.7	mm
Cover lens thickness	0.7	mm
Resolution	>100 dpi	
Input force	<10g	
Surface hardness	>6H	

2. Electrical Characteristics (Ta=25□)

Item	Symbol	Condition	Min.	Type	Max.	Unit
Power Supply	VCC	--	2.8	3.3	3.5	Volt
Supply Current	IDD	Vcc =3.3V Free mode	-	16.5	35	mA
		Vcc =3.3V watch mode	-	16.5	35	mA
		Vcc =3.3V Active mode	-	18.5	40	mA
		Vcc =3.3V Fast mode	-	18.5	40	mA



3. Optical Characteristics

Item	CONTENTS	Remark
Transparency	>87%	

4. Reliability

No.1	Test Items	Test Condition	Remark
1	High Temperature Storage Test	Ta= 70°C 240 hours	(1),(2)
2	Low Temperature Storage Test	Ta= -30°C 240 hours	(1),(2)
3	High Temperature Operation Test	Ta= 70°C 24 hours	(1),(2)
4	Low Temperature Operation Test	Ta= -20°C 24 hours	(1),(2)
5	High Temperature and High Humidity Operation Test	Ta=60°C 90%RH 240 hours (Without dewing)	(1),(2)
6	Thermal Shock Test (non-operating)	-20°C(30min) ~ 70°C(30min), 10 cycles	(1),(2)

Note:

(1) After the reliability test, the product should work functionally.

(2) Before visual and function test, the product should be given at least 2 hours at room temperature to normalize.

6. Touch panel description

6.1 Block diagram

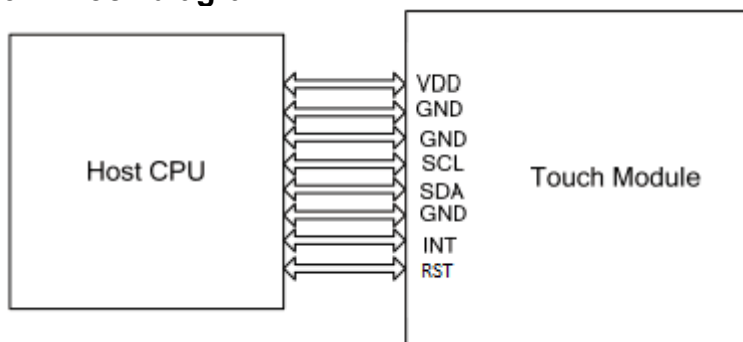

6.2 Touch panel pin assignment

Pin	Symbol	Description
1	VDD	Power supply
2	GND	Power ground.
3	GND	Power ground.
4	SCL	IIC clock signal. Must be pulled high.
5	SDA	IIC data signal. Must be pulled high.
6	GND	Power ground.
7	INT	External interrupt to the host
8	RST	External Reset, Low is active

7. Appearance Inspection

7.1 Conditions and methods of appearance inspection

7.1.1 Inspection distance: 25~30cm

7.1.2 From lamp source to product: 250cm

7.1.3 Angle of inspection: Ambient brightness 1k-1.5k lux inspection from front view, perpendicular to the surface of product.

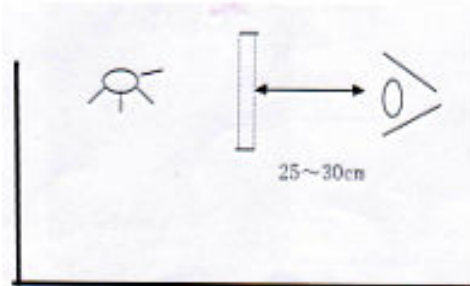

7.1.4 For pin hole defect is determined by the size of D dot diameter, irregular dot defect is determined by $D = (\text{length} + \text{width})/2$.

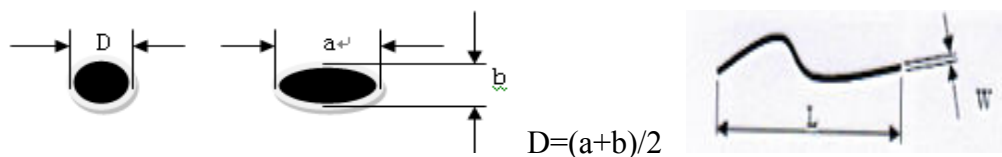





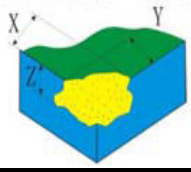
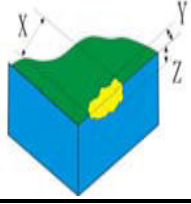
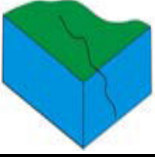
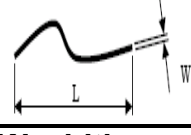

7.2 Products appearance standard:

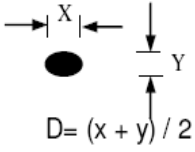
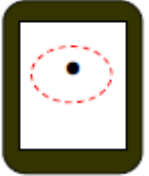
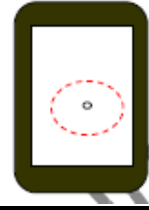
Defect Description	10.1 " TP standard	Defects classification		urges
		MA	MI	
Corner chip 	$X \leq 1.0\text{mm}; Y \leq 1.0\text{mm}; Z \leq 1/2T$; unilateral allowed 1		★	OK
	$X > 1.0\text{mm}, Y > 1.0\text{mm}$		★	NG
Edge chip 	$X \leq 1.0\text{mm}; Y \leq 1.0\text{mm}, Z \leq 1/2T$; unilateral allowed 1		★	OK
	$X > 1.0\text{mm}, Y > 1.0\text{mm}$		★	NG
	1. Touch sensor corner and edge chip that do not cause any damage to tracer and not visible to end-user after housing assembly. 2. Lens edge and corner chip that is not visible to end-user after housing assembly.		★	OK
	Sensor surface edge/corner breakage damage circuit and visible from front view		★	NG
Glass crack 	Any crack	★		NG
Line shape (including scratch fiber)  W:width L:length	$W \leq 0.03\text{mm}$, ignore		★	OK
	$0.05 \text{ mm} \leq W \leq 0.1 \text{ mm}, L \leq 3\text{mm}$, allowed two lines, distance should above 10mm		★	OK
	$W > 0.1\text{mm}, L > 3\text{mm}$		★	NG



Foreign round shape (e.g. white dot, black dot, air bubble) D = diameter  	$D \leq 0.15$ mm, ignore, the whole surface and dense dots not allowed.		★	OK
	$0.15 \text{ mm} < D \leq 0.25$ mm, allowed two dots, distance should be above 10mm		★	OK
	$D > 0.25$ mm	★		NG
Dent 	$D \leq 0.15$ mm, ignore, the whole surface and dense dots not allowed.		★	OK
	$0.15 \text{ mm} < D \leq 0.25$ mm, allowed two dots, distance should be above 10mm.		★	OK
	$D > 0.25$ mm	★		NG
Printing ink light leakage 	Light leakage at marginal area width ≤ 0.15 mm		★	OK
	Light leakage at marginal area, width > 0.15 mm	★		NG
Surface smudginess	For those that can be cleaned, $\leq 20\%$ of inspected quantity in one lot under $>$ class 10K area; $\leq 10\%$ of inspected quantity in one lot \leq class 10K area		★	OK
	For those that cannot be cleaned it is classified as foreign round shape defect		★	OK

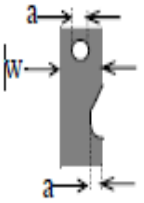

FPC defects on contact pad 	Dent, pinhole $a \leq w/3$		★	OK
	Open circuit /cracking	★		NG
	Oxidation, contamination	★		NG
FPC broken 	FPC broken /extruded	★		NG
FPC warped 	FPC warped		★	OK